

FS750 Series

FAST ETHERNET WEB-SMART SWITCHES

AT-FS750/20

AT-FS750/28

AT-FS750/28PS

AT-FS750/52



Installation Guide

Copyright © 2015 Allied Telesis, Inc.

All rights reserved. No part of this publication may be reproduced without prior written permission from Allied Telesis, Inc. Microsoft and Internet Explorer are registered trademarks of Microsoft Corporation. Netscape Navigator is a registered trademark of Netscape Communications Corporation. All other product names, company names, logos or other designations mentioned herein are trademarks or registered trademarks of their respective owners.

Allied Telesis, Inc. reserves the right to make changes in specifications and other information contained in this document without prior written notice. The information provided herein is subject to change without notice. In no event shall Allied Telesis, Inc. be liable for any incidental, special, indirect, or consequential damages whatsoever, including but not limited to lost profits, arising out of or related to this manual or the information contained herein, even if Allied Telesis, Inc. has been advised of, known, or should have known, the possibility of such damages.

Electrical Safety and Emissions Standards

This section contains the following:

- “US Federal Communications Commission”
- “Industry Canada”
- “Emissions, Immunity and Electrical Safety Standards” on page 4
- “Translated Safety Statements” on page 4

US Federal Communications Commission

Radiated Energy

Note

This equipment has been tested and found to comply with the limits for a Class A digital device pursuant to Part 15 of FCC Rules. These limits are designed to provide reasonable protection against harmful interference when the equipment is operated in a commercial environment. This equipment generates, uses, and can radiate radio frequency energy and, if not installed and used in accordance with this instruction manual, may cause harmful interference to radio communications. Operation of this equipment in a residential area is likely to cause harmful interference in which case the user will be required to correct the interference at his own expense.

Note

Modifications or changes not expressly approved of by the manufacturer or the FCC, can void your right to operate this equipment.

Industry Canada

Radiated Energy

This Class A digital apparatus complies with Canadian ICES-003.

Cet appareil numérique de la classe A est conforme à la norme NMB-003 du Canada.

Emissions, Immunity and Electrical Safety Standards

RFI Emissions FCC Class A, EN55022 Class A, CISPR 22 Class A, VCCI Class A, C-TICK



Warning

In a domestic environment this product may cause radio interference in which case the user may be required to take adequate measures. ⚡ E70

EMC (Immunity) EN55024, EN61000-3-2, EN61000-3-3

Electrical Safety EN60950-1 (TUV), UL 60950-1 (CULUS)



Warning

Laser Safety: EN60825 ⚡ L7

Translated Safety Statements

Important: The ⚡ indicates that translations of the safety statement are available in the PDF document “**Translated Safety Statements**” posted on the Allied Telesis website at alliedtelesis.com/support.

Contents

Symbol Conventions	8
Contacting Allied Telesis	9
Chapter 1: Overview	11
Features	12
Twisted-Pair Ports	12
SFP Slots	12
LEDs	13
Installation Options	13
MAC Address Table	13
Switch Front Panels	14
AT-FS750/20 Model	14
AT-FS750/28 Model	14
AT-FS750/28PS Model	14
AT-FS750/52 Model	15
Management Software	16
Twisted-Pair Ports	17
Combo Ports	18
LEDs	19
Power LED	19
10/100Base-T Port LEDs	19
10/100/1000 Base-T Port LEDs	19
SFP LEDs	20
SYS LED (AT-FS750/28PS)	20
POE MAX LED (AT-FS750/28PS)	21
Port POE LED (AT-FS750/28PS)	21
Reset Button	22
Power Supply	23
Chapter 2: Installation	25
Reviewing Safety Precautions	26
Selecting a Site for the Switch	30
Cable Specifications	31
Unpacking the Switch	32
Installing the Switch on a Desktop or Table	33
Installing the Switch in an Equipment Rack	34
Installing the Switch on a Wall	36
Installing SFP Transceivers	38
Cabling the Switch	40
Powering On the Switch	41
Chapter 3: Troubleshooting	43
Appendix A: Technical Specifications	45
Physical Specifications	45
Dimensions	45
Weight	45

Contents

Environmental Specifications	46
Power Specifications	46
Safety and Electromagnetic Emissions Certifications	46
Connectors and Port Pinouts.....	48

Preface

This manual is the installation guide for the FS750 Series Fast Ethernet switches. The switches included in this series are:

- AT-FS750/20
- AT-FS750/28
- AT-FS750/28PS
- AT-FS750/52

This preface includes the following sections:

- “Symbol Conventions” on page 8
- “Contacting Allied Telesis” on page 9

Symbol Conventions

This document uses the following conventions:

Note

Notes provide additional information.

**Caution**

Cautions inform you that performing or omitting a specific action may result in equipment damage or loss of data.

**Warning**

Warnings inform you that performing or omitting a specific action may result in bodily injury.

**Warning**

Warnings inform you that an eye and skin hazard exists due to the presence of a Class 1 laser device.

Contacting Allied Telesis

If you need assistance with this product, you may contact Allied Telesis technical support by going to the Support & Services section of the Allied Telesis web site at **alliedtelesis.com/support**. You can find links for the following services on this page:

- 24/7 Online Support — Enter our interactive support center to search for answers to your product questions in our knowledge database, check support tickets, learn about Return Merchandise Authorizations (RMAs), and contact Allied Telesis technical experts.
- USA and EMEA phone support - Select the phone number that best fits your location and customer type.
- Hardware warranty information - Learn about Allied Telesis warranties and register your product online.
- Replacement Services — Submit an RMA request via our interactive support center.
- Documentation - View the most recent installation guides, user guides, software release notes, white papers and data sheets for your product.
- Software Updates - Download the latest software releases for your product.

For sales or corporate contact information, go to **alliedtelesis.com/purchase** and select your region.

Chapter 1

Overview

This chapter provides descriptions of the AT-FS750/20, AT-FS750/28, AT-FS750/28PS, and AT-FS750/52 switches and contains the following sections:

- “Features” on page 12
- “Switch Front Panels” on page 14
- “Management Software” on page 16
- “Twisted-Pair Ports” on page 17
- “Combo Ports” on page 18
- “LEDs” on page 19
- “Reset Button” on page 22
- “Power Supply” on page 23

Features

Here are the hardware features of the FS750 Series Fast Ethernet switches.

Twisted-Pair Ports

The FS750 Series Fast Ethernet switches have 16, 24, or 48 10/100 Mbps ports and four 10/100/1000Mbps ports.

Here are the basic features of 10/100 Mbps ports and 10/100/1000Mbps ports:

- IEEE802.3 compliant for 10Base-T ports
- IEEE802.3u compliant for 100Base-TX ports
- IEEE802.3ab compliant for 1000Base-T ports
- IEEE 802.3u Auto-Negotiation compliant on 10/100Mbps ports
- Auto-MDI/MDIX on 10/100Mbps ports
- 100 meters (328 feet) maximum operating distance
- IEEE 802.3x Flow Control in full-duplex operation
- Back Pressure Flow Control in half-duplex operation
- RJ-45 connectors
- Two SFP slots for combo ports

SFP Slots

The FS750 series switches support both 100Base-FX and 1000Base-SX/LX on the SFP slots.

The SFP slots are paired with twisted pair ports on the switch to form combo ports. For more information, see “Combo Ports” on page 18.

Note

You must purchase SFP transceivers separately. For a list of supported transceivers, contact your Allied Telesis distributor or reseller.

Note

See the product data sheets for the specific ATI SFP modules supported by the FS750 Series Fast Ethernet switches.

LEDs The following lists the switch LEDs:

- Speed and link/activity LEDs for the 10/100Base-T ports
- LEDs that indicate 10/100M or 1000M speed and link/activity for the 10/100/1000Base-T ports
- Power LED
- SYS LED (available only for the AT-FS750/28PS model)
- POE MAX LED (available only for the AT-FS750/28PS model)
- Port POE LEDs (available only for the AT-FS750/28PS model)

Installation Options The FS750 Series Fast Ethernet switches can be installed in the following ways:

- Rack mounted in a 19-inch equipment rack
- Mounted on a desk or tabletop

Note

Rack mounting hardware is included in the shipping package.

MAC Address Table Here are the basic features of the MAC address table:

- Storage capacity up to 8KB MAC address entries for the AT-FS750/20, AT-FS750/28, AT-FS750/28PS switches
- Storage capacity up to 16KB MAC address entries for the AT-FS750/52 switch
- Automatic learning and aging

Switch Front Panels

This section shows the design of the front panel for each model.

AT-FS750/20 Model

Figure 1 illustrates the front panel of the AT-FS750/20 switch.

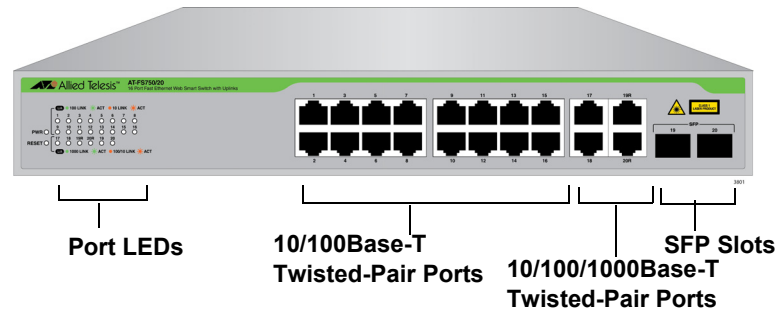

Figure 1. AT-FS750/20 Switch Front Panel

AT-FS750/28 Model

Figure 2 illustrates the front panel of the AT-FS750/28 switch.

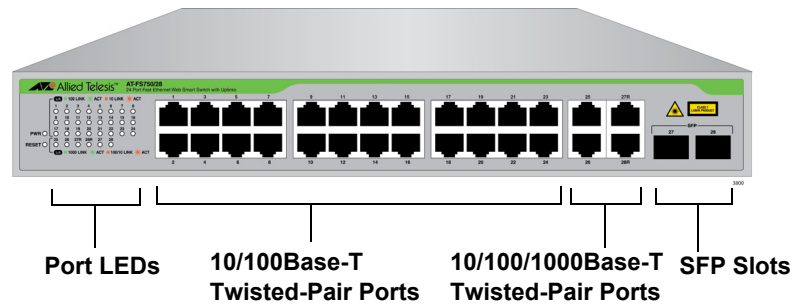

Figure 2. AT-FS750/28 Switch Front Panel

AT-FS750/28PS Model

Figure 3 illustrates the front panel of the AT-FS750/28PS switch.

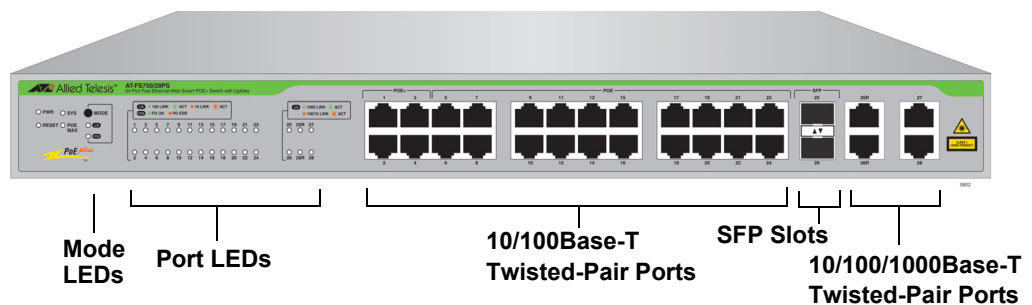

Figure 3. AT-FS750/28PS Switch Front Panel

**AT-FS750/52
Model**

Figure 4 illustrates the front panel of the AT-FS750/52 switch.

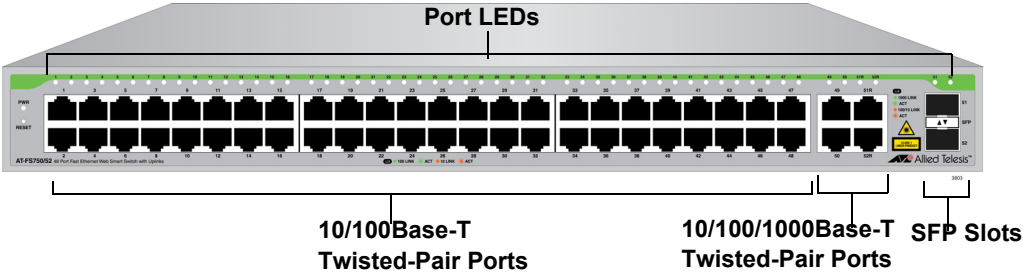

Figure 4. AT-FS750/52 Switch Front Panel

Management Software

The FS750 Series Fast Ethernet switches are shipped with the WebSmart management software pre-installed. The software provides a web-browser interface for in-band, over-the-network management.

In the unlikely event that the management software becomes corrupted or damaged on the switch, you can download the software from the Allied Telesis corporate web site and reinstall it on the switch. For instructions on how to install new management software, see the FS750 Series Fast Ethernet Switches Web User's Guide.

Twisted-Pair Ports

The AT-FS750/20, AT-FS750/28, AT-FS750/28PS, and AT-FS750/52 Fast Ethernet Switches feature 16, 24, 24, and 48 twisted-pair ports, respectively. These ports are 10Base-T and 100Base-TX compliant. You can set the port speeds and duplex modes either automatically with IEEE 802.3u Auto-Negotiation or manually with the WebSmart management software.

The twisted-pair ports feature 8-pin RJ-45 connectors. For the port pinouts, see “Connectors and Port Pinouts” on page 48.

The ports have a maximum operating distance of 100 m (328 feet). For 10 Mbps operation, the ports require Category 3 or better 100 ohm shielded or unshielded twisted-pair cabling. For 100 Mbps operation, the ports require Category 5 or Enhanced Category 5 (5E) 100 ohm shielded or unshielded twisted-pair cabling.

The ports feature auto-MDI, which automatically configures the ports as MDI or MDI-X. This feature allows you to use straight-through twisted-pair cables, regardless of the wiring configurations of the ports on the end nodes.

Note

A switch port connected to an end node that is not using Auto-Negotiation should not use Auto-Negotiation to set the speed and duplex mode, because a duplex-mode mismatch may occur. In this case, disable Auto-Negotiation and set the port's speed and duplex mode manually.

Combo Ports

The FS750 Series Fast Ethernet switches have two pairs of combo ports. Each combo port consists of one 10/100/1000Base-T twisted-pair port and one slot for an optional 100Base-FX or 1000Base-SX/LX SFP transceiver. The twisted-pair ports are identified with the letter “R” for “Redundant” on the front face plates of the units. The combo ports and SFP slots are listed in Table 1.

Table 1. Combo Ports

Switch	Twisted-Pair Port	SFP Slot
AT-FS750/20	19R	19
	20R	20
AT-FS750/28	27R	27
	28R	28
AT-FS750/28PS	25R	25
	26R	26
AT-FS750/52	51R	51
	52R	52

The combo ports have the guidelines listed here:

- Only one port in a pair, either the twisted-pair port or a corresponding SFP module, can be active at a time.
- The twisted-pair port is the active port when its SFP slot is empty, or when an SFP module is installed, but has not established a link to an end node.
- The twisted-pair port automatically changes to the redundant status mode when an SFP module establishes a link with an end node.
- A twisted-pair port automatically transitions back to the active status when the link is lost on the SFP module.
- In nearly all cases, a twisted-pair port and an SFP module share the same configuration settings, including port settings, VLAN assignments, access control lists, and spanning tree.
- An exception to the shared settings is port speed. If you disable Auto-Negotiation on a twisted-pair port and set the speed and duplex mode manually, the speed reverts to Auto-Negotiation when an SFP module establishes a link with an end node.

LEDs

The FS750 Series Fast Ethernet switches are equipped with LEDs to indicate the switch status.

Power LED

Table 2 describes the power LED.

Table 2. Power LED

LED	State	Description
PWR	Off	The switch is not receiving power.
	Green	The input AC power is within the normal operating range.

10/100Base-T Port LEDs

Table 3 describes the Link/Activity and speed LEDs for the 10/100Base-T ports.

Note

To see the Link/Activity and speed status for the AT-FS750/28PS model, you must select the L/A option by toggling the MODE button.

Table 3. 10/100Base-T Port LEDs

LED	State	Description
L/A	Off	The port has not established a link with a network device.
	Steady Green	The port has established a link to a network device and can operate at 100 Mbps.
	Blinking Green	The port is transmitting or receiving network packets and operating at 100 Mbps.
	Steady Amber	The port has established a link to a network device and can operate at 10 Mbps.
	Blinking Amber	The port is transmitting or receiving network packets and operating at 10 Mbps.

10/100/1000 Base-T Port LEDs

Table 4 describes the Link/Activity and speed LEDs for the 10/100/1000Base-T ports.

Note

To see the Link/Activity and speed status for the AT-FS750/28PS model, you must select the L/A option by toggling the MODE button.

Table 4. 10/100/1000Base-T Port LEDs

LED	State	Description
L/A	Off	The port has not established a link with a network device.
	Blinking Green	The port is transmitting or receiving network packets and operating at 1000 Mbps.
	Steady Green	The port has established a link to a network device and can operate at 1000 Mbps.
	Blinking Amber	The port is transmitting or receiving network packets and operating at 10 or 100 Mbps.
	Steady Amber	The port has established a link to a network device and can operate at 10 or 100 Mbps.

SFP LEDs Table 5 describes the LEDs for SFP ports.

Table 5. SFP Port LEDs

LED	State	Description
SFP per Port	Off	The port has not established a link with a network device.
	Steady Green	The port has established a link to a network device and can operate at 1000Mbps.
	Blinking Green	The port is transmitting or receiving network packets and operating at 1000Mbps.
	Steady Amber	The port is transmitting or receiving network packets and operating at 100Mbps.
	Steady Amber	The port is transmitting or receiving network packets and operating at 100Mbps.

SYS LED (AT-FS750/28PS) Table 6 describes the SYS LED. This LED is available only for the AT-FS750/28PS switch.

Table 6. SYS LED

LED	State	Description
SYS	Off	The system is not receiving power.
	Red	The system is not ready for its operation.
	Green	The system is up and operating normally.

POE MAX LED (AT-FS750/28PS)

Table 7 describes the POE MAX LED. This LED is available only for the AT-FS750/28PS switch.

Table 7. POE MAX LED

LED	State	Description
POE MAX	Off	The switch has spare power for a new PD.
	Red	The total PoE output power for all ports on the switch exceeds the maximum PoE power that the switch can deliver.

Port POE LED (AT-FS750/28PS)

Table 8 describes the PoE LEDs for ports. The PoE LEDs are available only for the AT-FS750/28PS switch.

Note

To see the port PoE status, you must select the POE option by toggling the MODE button.

Table 8. Port POE LEDs

LED	State	Description
POE	Off	PoE power is not being supplied.
	Green	PoE power is being supplied to the PD normally.
	Amber	The total PoE output power for this port exceeds the maximum power budget for the switch.

Reset Button

To reset your switch, press the RESET button on the front panel.

Pressing the reset button initiates a system reboot of the switch and reloads the current configuration file.



Caution

The switch does not forward network traffic during the reset process.

↻ E87

Power Supply

Each switch has an internal power supply with a single AC power supply socket on the back panel. To power the switch on or off, connect or disconnect the power cord provided with the switch. A power cord is supplied with the switch.

Note

For the power requirements, see the “Power Specifications” on page 46.

Chapter 2

Installation

This chapter contains the following sections:

- “Reviewing Safety Precautions” on page 26
- “Selecting a Site for the Switch” on page 30
- “Cable Specifications” on page 31
- “Unpacking the Switch” on page 32
- “Installing the Switch on a Desktop or Table” on page 33
- “Installing the Switch in an Equipment Rack” on page 34
- “Installing the Switch on a Wall” on page 36
- “Installing SFP Transceivers” on page 38
- “Cabling the Switch” on page 40
- “Powering On the Switch” on page 41

Reviewing Safety Precautions

Please review the following safety precautions before you begin to install the chassis or any of its components.

Note

Important: The  indicates that translations of the safety statement are available in the PDF document “Translated Safety Statements” posted on the Allied Telesis website at alliedtelesis.com/support.



Warning

Class 1 Laser product.  L1



Warning

Do not stare into the laser beam.  L2



Warning

Do not look directly at the fiber optic cable ends or inspect the cable ends with an optical lens.  L6



Warning

Laser Safety: EN60825.  L7



Warning

To prevent electric shock, do not remove the cover. No user-serviceable parts inside. This unit contains hazardous voltages and should only be opened by a trained and qualified technician. To avoid the possibility of electric shock, disconnect electric power to the product before connecting or disconnecting the cables.  E1



Warning

Do not work on equipment or cables during periods of lightning activity.  E2

**Warning**

Power cord is used as a disconnection device. To de-energize equipment, disconnect the power cord. ⚡ E3

**Warning**

Class I Equipment. This equipment must be earthed. The power plug must be connected to a properly wired earth ground socket outlet. An improperly wired socket outlet could place hazardous voltages on accessible metal parts. ⚡ E4

Note

Pluggable Equipment. The socket outlet shall be installed near the equipment and shall be easily accessible. ⚡ E5

**Caution**

Air vents must not be blocked and must have free access to the room ambient air for cooling. ⚡ E6

Note

All Countries: Install product in accordance with local and National Electrical Codes. ⚡ E8

Note

Circuit Overloading: Consideration should be given to the connection of the equipment to the supply circuit and the effect that overloading of circuits might have on over current protection and supply wiring. Appropriate consideration of equipment nameplate ratings should be used when addressing this concern. ⚡ E21

**Warning**

Mounting of the equipment in the rack should be such that a hazardous condition is not created due to uneven mechanical loading. ⚡ E25

Note

If installed in a closed or multi-unit rack assembly, the operating ambient temperature of the rack environment may be greater than the room ambient temperature. Therefore, consideration should be given to installing the equipment in an environment compatible with the manufacturer's maximum rated ambient temperature (Tmra).

↻ E35



Caution

Installation of the equipment in a rack should be such that the amount of air flow required for safe operation of the equipment is not compromised. ↻ E36



Warning

Reliable earthing of rack-mounted equipment should be maintained. Particular attention should be given to supply connections other than direct connections to the branch circuits (e.g., use of power strips).

↻ E37



Warning

When you remove an SFP module from this product, the case temperature of the SFP may exceed 70° C (158° F). Exercise caution when handling with unprotected hands. ↻ E43



Warning

Operating Temperature. This product is designed for a maximum ambient temperature of 50 degrees C. ↻ E57



Warning

In a domestic environment this product may cause radio interference in which case the user may be required to take adequate measures. ↻ E84



Warning

An SFP transceiver can be damaged by static electricity. Be sure to observe all standard electrostatic discharge (ESD) precautions, such as wearing an antistatic wrist strap, to avoid damaging the transceiver. ↻ E86



Caution

The switch does not forward network traffic during the reset process.

∞ E87

Selecting a Site for the Switch

Observe the following requirements when choosing a site for your switch:

- If you plan to install the switch in an equipment rack, verify that the rack is safely secured and will not tip over. Devices in a rack should be installed starting at the bottom, with the heavier devices near the bottom of the rack.
- If you are installing the switch on a table, verify that the table is level and secure.
- The power outlet for the switch should be located near the unit and should be easily accessible.
- The site should provide for easy access to the ports on the front of the switch. This will make it easier for you to connect and disconnect cables, as well as view the switch's LEDs.
- Air flow around the unit and through its vents on the side and rear should not be restricted so that the switch can maintain adequate cooling.
- Do not place objects on top of the switch.
- Do not expose the switch to moisture or water.
- Ensure that the site is a dust-free environment.
- You should use dedicated power circuits or power conditioners to supply reliable electrical power to the network devices.

Cable Specifications

Table 9 contains the cable specifications for the twisted-pair ports.

Table 9. Twisted-Pair Cabling and Distances

Speed	Type of Cable	Maximum Operating Distance
10 Mbps	Standard TIA/EIA 568-B-compliant Category 3 or better shielded or unshielded cabling with 100 ohm impedance and a frequency of 16 MHz.	100 m (328 ft)
100 Mbps	Standard TIA/EIA 568-A-compliant Category 5 or TIA/EIA 568-B-compliant Enhanced Category 5 (Cat 5e) shielded or unshielded cabling with 100 ohm impedance and a frequency of 100 MHz.	100 m (328 ft)
1000 Mbps	Standard TIA/EIA 568-A-compliant Category 5 or TIA/EIA 568-B-compliant Enhanced Category 5 (Cat 5e) shielded or unshielded cabling with 100 ohm impedance and a frequency of 100 MHz.	100 m (328 ft)

Note

The twisted-pair ports on the switch feature auto-MDI when operating at 10, 100, or 1000 Mbps. A port is configured as MDI or MDI-X when it is connected to an end node. Consequently, you can use a straight-through twisted-pair cable when connecting any type of network device to a port on the switch.

Unpacking the Switch

To unpack the switch, perform the following procedure:





1. Remove all of the components from the shipping package.

Note

Store the packaging material in a safe location. You must use the original shipping material if you need to return the unit to Allied Telesis.

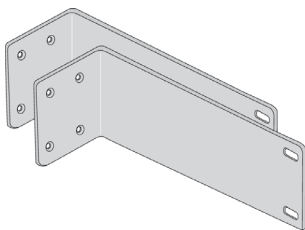
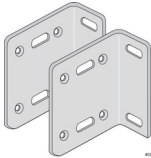
2. Place the switch on a level, secure surface.
3. In addition to the switch, verify that the shipping container includes the following items shown in Table 10.

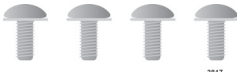
Table 10. Packing List

	AT-FS750/20 and AT-FS750/28	AT-FS750/28PS and AT-FS750/52
Two equipment rack or wall brackets		
Eight bracket screws		
Four wall screws		
Four rubber feet (for desktop installation)		
One regional AC power cord		

Installing the Switch on a Desktop or Table

You may install the switches on a desktop or table, or in a standard 19-inch equipment rack. To install the switch in a rack, see “Installing the Switch in an Equipment Rack” on page 34.

To place the switch on a desktop or table, perform the following procedure:

1. Remove all equipment from the package and store the packaging material in a safe place.
2. Turn the switch over and place it on a table.
3. Attach the four rubber feet to the bottom of the switch as shown in Figure 5.

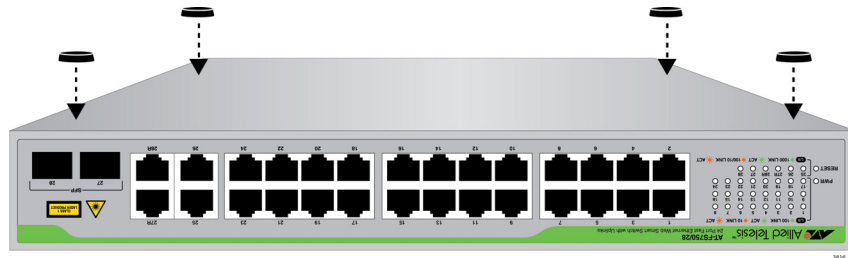

Figure 5. Attaching the Rubber Feet

4. Place the switch on a flat, secure surface (such as a desk or table) leaving ample space around the unit for ventilation.
5. Go to “Installing SFP Transceivers” on page 38 or “Cabling the Switch” on page 40.

Installing the Switch in an Equipment Rack

To install the switch in a standard 19-inch equipment rack, perform the following procedure:

1. If the rubber feet are attached to the bottom of the switch, remove them using a flat-head screwdriver.
2. Attach the two rack mount brackets to the sides of the switch using the bracket screws that come with the unit. See Figure 6.

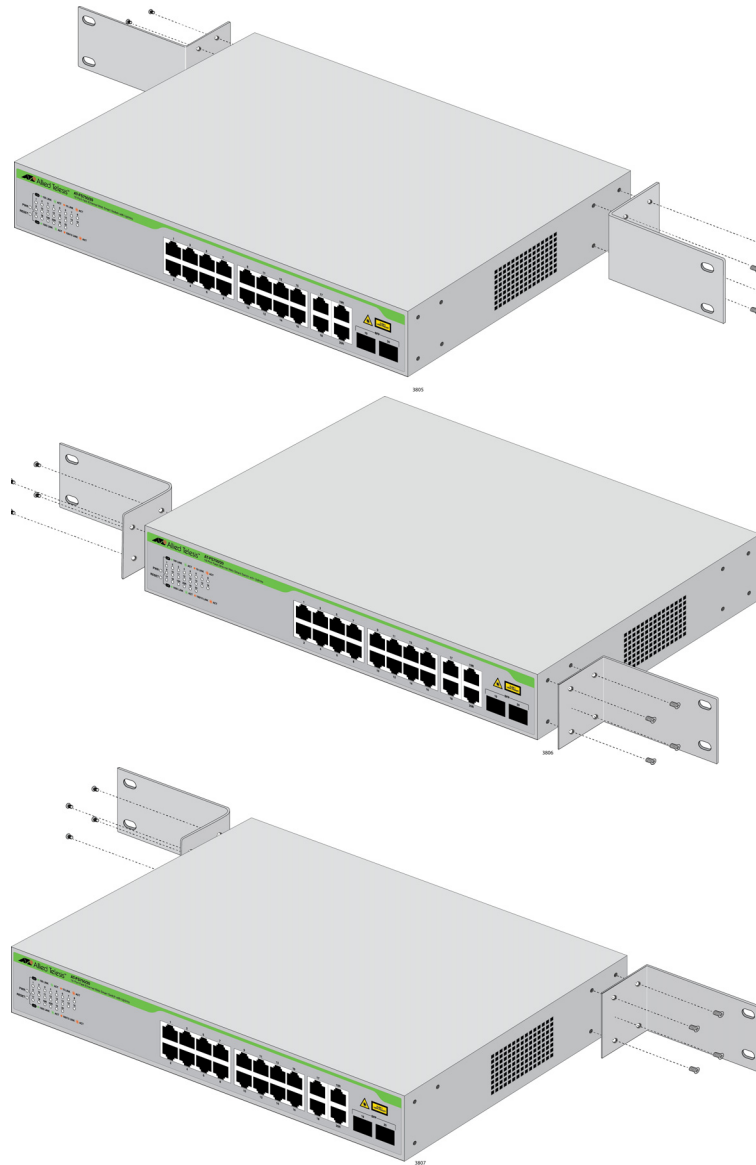

Figure 6. Attaching the Rack-Mount Brackets to the Switch

3. Mount the switch in a standard 19-inch equipment rack using four equipment rack screws (not provided with the switch) as shown in Figure 7.

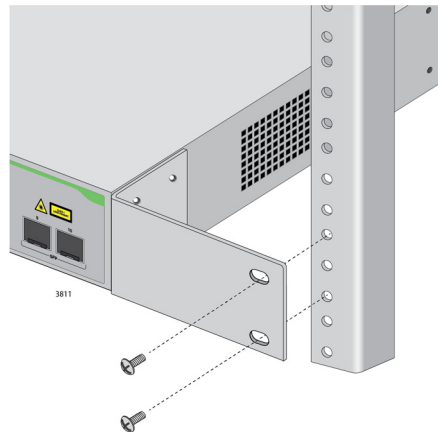

Figure 7. Mounting the Switch in an Equipment Rack

4. Go to “Installing SFP Transceivers” on page 38 or “Cabling the Switch” on page 40.

Installing the Switch on a Wall

To install the switch on a wall, perform the following procedure:

1. Turn the switch over and place it on a table.
2. If the rubber feet are attached to the bottom of the switch, remove them using a flat-head screwdriver.
3. Orient the brackets against the sides of the switch as shown in Figure 8, and secure them to the unit with the eight brackets screws included with the switch.

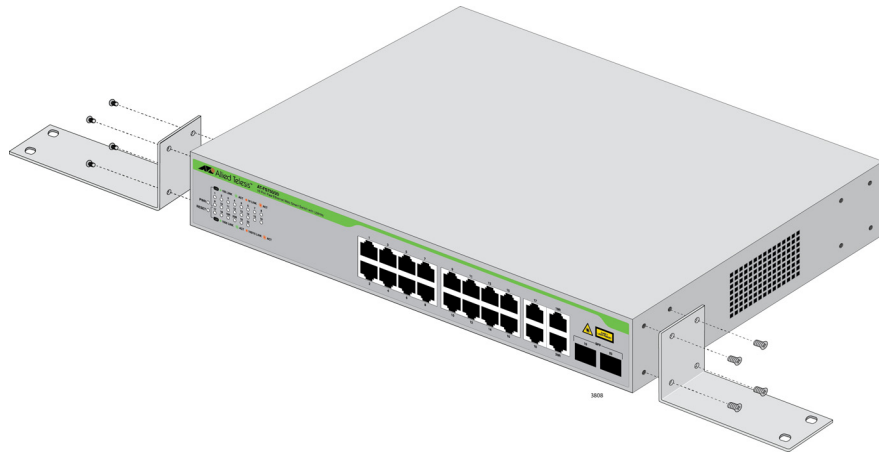

Figure 8. Attaching the Brackets to Install the Switch on a Wall

4. Have another person hold the switch at the wall location where the switch is to be installed, while you use a pencil or pen to mark the wall with the locations of the four holes in the brackets. The switch should be oriented such that its front faceplate is facing up and is level to the floor. See Figure 9 on page 36.

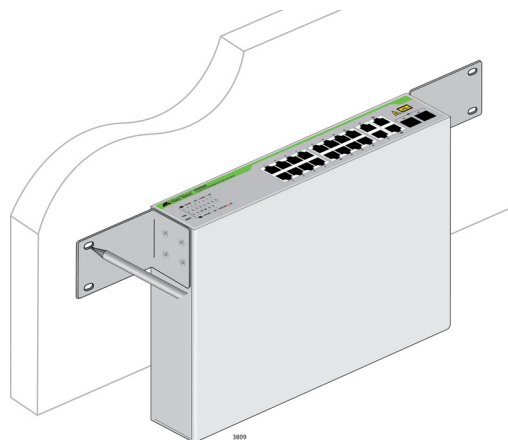

Figure 9. Marking the Screw Hole Locations

5. Install the four plastic anchors included with the switch into the wall, at the locations marked in the previous step. The anchors require 0.635 mm (0.25 in.) holes.
6. While another person holds the switch at the wall location, secure it to the wall using the four wall mounting screws. See Figure 10 on page 37.

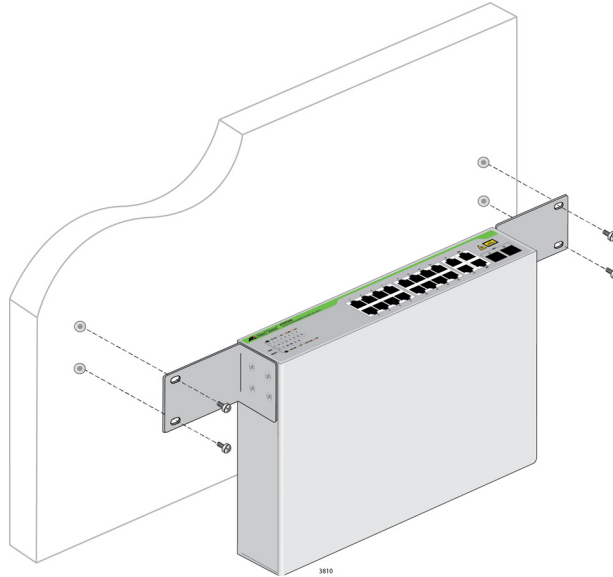

Figure 10. Securing the Switch to the Wall

7. Go to “Installing SFP Transceivers” on page 38 or “Cabling the Switch” on page 40.

Installing SFP Transceivers

To install an SFP transceiver, perform the following procedure:

Note

The transceiver can be hot-swapped; you do not need to power off the switch to install a transceiver. However, you should always remove the cables before removing the transceiver.

Note

You should always install the transceiver before connecting the fiber-optic cables to it.

1. Remove the transceiver from its shipping container and store the packaging material in a safe location.



Warning

An SFP transceiver can be damaged by static electricity. Be sure to observe all standard electrostatic discharge (ESD) precautions, such as wearing an anti-static wrist strap, to avoid damaging the transceiver. *See* E86

2. Position the SFP transceiver with the label facing up.
3. Slide the transceiver into the SFP slot until it clicks into place. See Figure 11.

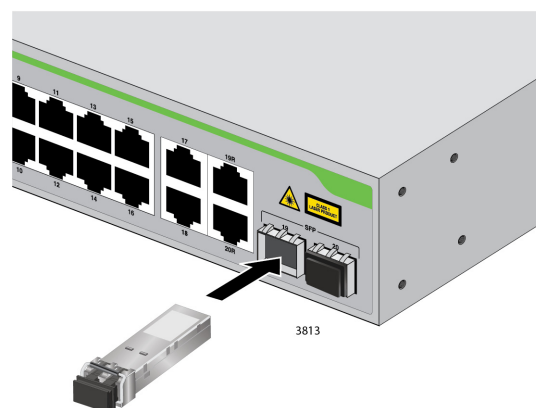

Figure 11. Inserting the SFP

4. Verify that the handle on the transceiver is in the upright position, as shown in Figure 12. This secures the transceiver and prevents it from being dislodged from the slot.

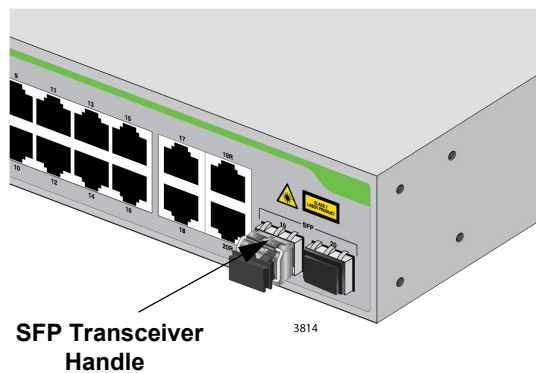

Figure 12. SFP Handle in Upright Position

5. Repeat steps 2 through 5 to install an additional SFP transceiver.



Caution

When you remove an SFP module from this product, the case temperature of the SFP may exceed 70 C (158 F). Exercise caution when handling with unprotected hands. ⚡ E43

Note

Unnecessary removal and insertion of an SFP can lead to premature failure.

For information on the cable specifications of the SFP, consult the documentation shipped with the SFP.

6. Go to “Cabling the Switch” on page 40.

Cabling the Switch

Observe the following guidelines when connecting twisted-pair and fiber-optic cables to the ports on the switch:

- The connector on the cable should fit snugly into the port on the switch. The tab on the connector should lock the connector into place.
- Because the twisted-pair ports have auto-MDI/MDI-X, you may use straight-through twisted-pair cable to connect any type of network device to the switch.
- If your network topology contains a loop where two or more network devices can communicate with each other over more than one network path, do not connect the network cables that form the loop until after you activate a spanning tree protocol on the switch. Data loops can adversely affect network performance.
- If you are creating a port trunk, do not connect the cables of the trunk to the switch until after you have created the trunk in the switch's management software and the management software of the switch at the other end of the trunk cables. Otherwise, a network loop will result which can adversely affect network performance.

Powering On the Switch

To power on the switch, perform the following procedure:

1. Plug the power cord into the AC power connector on the back of the switch, as shown in Figure 13.

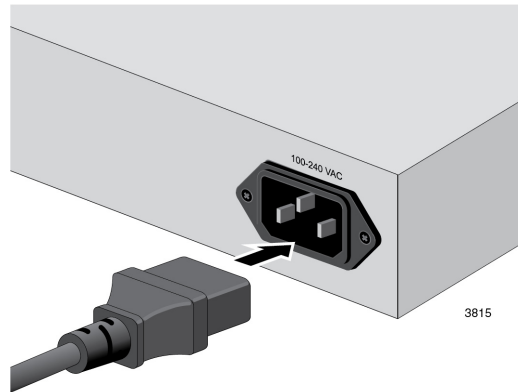

Figure 13. Plugging in the AC Power Cord

2. Plug the other end of the power cord into a wall outlet.



Warning

Power cord is used as a disconnection device. To de-energize equipment, disconnect the power cord. ⚡ E3

Note

Pluggable Equipment. The socket outlet shall be installed near the equipment and shall be easily accessible. ⚡ E5

3. Verify that the POWER LED is green. If the LED is OFF, see Chapter 3, “Troubleshooting” on page 43.
4. If your switch is an AT-FS750/28PS model, verify the SYS LED is green.

The switch is now powered on and ready for network operations. For information on how to manage the switch, see the FS750 Series Web Management User’s Guide.

Chapter 3

Troubleshooting

This chapter contains information on how to troubleshoot the switch if a problem occurs.

Note

For further assistance, please contact Allied Telesis Technical Support at alliedtelesis.com/support.

Problem 1: The POWER LED on the front of the switch is off.

Solutions: The unit is not receiving power. Try the following:

- Verify that the power cord is securely connected to the power source and to the AC connector on the back panel of the switch.
- Verify that the power outlet has power by connecting another device to it.
- Try connecting the unit to another power source.
- Try a different power cord.
- Verify that the voltage from the power source is within the required levels for your region.

Problem 2: A twisted-pair port on the switch is connected to a network device, but the port's Link Activity LED is off.

Solutions: The port is unable to establish a link to a network device. Try the following:

- Verify that the network device connected to the twisted-pair port is powered on and is operating properly.
- Verify that the twisted-pair cable is securely connected to the port on the switch channel and to the port on the remote network device.
- Verify that the port is connected to the correct twisted-pair cable. This is to eliminate the possibility that the port is connected to the wrong network device, such as a powered-off device.
- Try connecting another network device to the twisted-pair port with a different cable. If the twisted-pair port is able to establish a link, then the problem is with the cable or the other network device.
- Verify that the twisted-pair cable does not exceed 100 meters (328 feet).

- Verify that you are using the appropriate category of twisted-pair cable: Category 3 or better for 10 Mbps operation and Category 5 and Category 5E for 100 Mbps operation.

Problem 3: The Link Activity LED for an SFP transceiver is off.

Solutions: The fiber-optic port on the transceiver is unable to establish a link to a network device. Try the following:

- Verify that the network device connected to the fiber-optic port is operating properly.
- Verify that the fiber-optic cable is securely connected to the port on the switch channel and to the port on the remote network device.
- Check that the SFP module is fully inserted in the slot.
- Verify that the operating specifications of the fiber-optic ports on the SFP transceiver and the remote network device are compatible.
- Verify that the correct type of fiber-optic cabling is being used.
- Verify that the port is connected to the correct fiber-optic cable. This is to eliminate the possibility that the port is connected to the wrong remote network device, such as a powered-off device.
- Try connecting another network device to the fiber-optic port using a different cable. If the port is able to establish a link, then the problem is with the cable or with the other network device.
- Use the switch's management software to verify that the port is enabled.
- If the remote network device is a management device, use its management firmware to determine whether its port is enabled.
- Test the attenuation on the fiber-optic cable with a fiber-optic tester to determine whether the optical signal is too weak (sensitivity) or too strong (maximum input power).

Problem 4: Network performance between a twisted-pair port on the switch and a network device is slow.

Solution: There might be a duplex-mode mismatch between the port and the network device. This occurs when a twisted-pair port using Auto-Negotiation is connected to a device with a fixed duplex mode of full duplex. If this is the cause of the problem, adjust the duplex mode of the port on the network device or on the switch so that both ports are using the same duplex mode.

Appendix A

Technical Specifications

This appendix contains the following specifications:

- “Physical Specifications”
- “Environmental Specifications” on page 46
- “Power Specifications” on page 46
- “Safety and Electromagnetic Emissions Certifications” on page 46
- “Connectors and Port Pinouts” on page 48

Physical Specifications

Dimensions Table 11 shows the chassis dimensions per model.

Table 11. Chassis Dimensions

Model	W x D x H mm (in)
AT-FS750/20	330 mm x 180 mm x 44 mm (13 in x 7.1 in x 1.7 in)
AT-FS750/28	330 mm x 180 mm x 44 mm (13 in x 7.1 in x 1.7 in)
AT-FS750/28PS and AT-FS750/52	440 mm x 250 mm x 44 mm (17.3 in x 9.8 in x 1.7 in)

Weight Table 12 shows the chassis weight per model.

Table 12. Chassis Weight

Model	kg (lbs)
AT-FS750/20	1.4 kg (3.1 lbs)
AT-FS750/28	2.0 kg (4.4 lbs)
AT-FS750/28PS	3.2 kg (7.2 lbs)
AT-FS750/52	2.7 kg (6 lbs)

Environmental Specifications

Table 13 shows the environmental specifications.

Table 13. Environmental Specifications

Operating Temperature	0° C to 40° C (32° F to 104° F)
Storage Temperature	-20° C to 70° C (-4° F to 158° F)
Operating Humidity	5% to 90% non-condensing
Storage Humidity	5% to 95% non-condensing

Power Specifications

Table 14 shows the power specifications.

Table 14. Power Specifications

Rated input voltage	100 to 240 VAC
Rated input frequency	50/60 Hz
Rated input current	0.7A

Safety and Electromagnetic Emissions Certifications

Table 15 shows the safety and electromagnetic emissions certifications.

Table 15. Safety and Electromagnetic Emissions Certifications

RFI Emissions	FCC Part 15 Class A CISPR 22 Class A EN55022:2006/A:2007 Class A
Immunity	EN55024
Electrical Safety	UL60950-1 (cULus), EN60950-1 (TUV), RCM, CE Mark
Environmental Compliance	EU-RoHS compliant, WEEE China RoHS compliant

Connectors and Port Pinouts

This section lists the connectors and connector pinouts.

Figure 14 illustrates the pin layout for an RJ-45 connector and port.

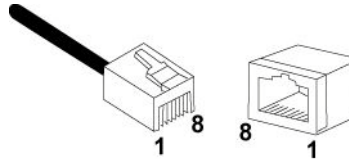

Figure 14. RJ-45 Connector and Port Pin Layout

Table 16 lists the RJ-45 pin signals when a twisted-pair port is operating in the MDI configuration.

Table 16. MDI Pin Signals (10Base-T or 100Base-TX)

Pin	Signal
1	TX+
2	TX-
3	RX+
6	RX-

Table 17 lists the RJ-45 port pin signals when a twisted-pair port is operating in the MDI-X configuration.

Table 17. MDI-X Pin Signals (10Base-T or 100Base-TX)

Pin	Signal
1	RX+
2	RX-
3	TX+
6	TX-

Table 18 lists the RJ-45 connector pins and their signals when a 1000Base-T port is operating at 1000 Mbps.

Table 18. RJ-45 1000Base-T Connector Pinouts

Pin	Pair	Signal
1	1	TX and RX+
2	1	TX and RX-
3	2	TX and RX+
4	3	TX and RX+
5	3	TX and RX-
6	2	TX and RX-
7	4	TX and RX+
8	4	TX and RX-

